

Vacuum gripper MPES

Vacuum gripper MPES

Suction area(φ)40mm to 180mm

Vacuum gripper MPES



System design Vacuum gripper MPES

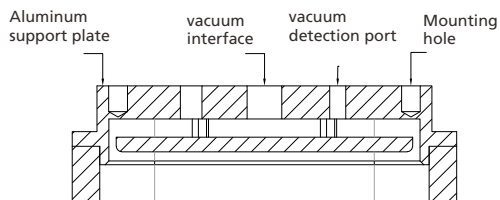

Introduction and application

- ◆ For grasping paper or plastic bags, packaging and flexible containers contain powder, granular products, loose or liquid products.

Structure

- ◆ Made of anodized aluminum and self-adhesive sponge.
- ◆ The middle threaded hole is used to fix the side hole for vacuum connection.

Ordering guide of vacuum gripper MPES

Type	suction area [mm]	material and shore hardness	connecting thread
MPES	120 × 60 to 400 × 300	GERANIUM	G3/8
			G1/2
			G1
			G2

Ordering data of vacuum gripper MPES

Type	ordering data	Type	ordering data
MPES 120 × 60 G3/8	90.02.01.00688	MPES 200 × 150 G1	90.02.01.00691
MPES 160 × 90 G1/2	90.02.01.00689	MPES 300 × 200 G1	90.02.01.00692
MPES 210 × 95 G1/2	90.02.01.00690	MPES 400 × 300 G2	90.02.01.00693

Technical parameter of vacuum gripper MPES

Type	Suction Ds[N]	weight [kg]	working temperature [°C]
MPES 120 × 60 G3/8	94	0.36	-40...80
MPES 160 × 90 G1/2	179	0.63	-40...80
MPES 210 × 95 G1/2	274	0.80	-40...80
MPES 200 × 150 G1	438	1.10	-40...80
MPES 300 × 200 G1	825	2.24	-40...80
MPES 400 × 300 G2	1744	3.85	-40...80

Vacuum gripper MPES



Vacuum gripper MPES

Suction area(φ)40mm to 180mm



Design parameter of vacuum gripper MPES

MPES 120 × 60 to 210 × 95

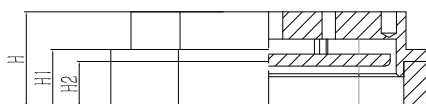
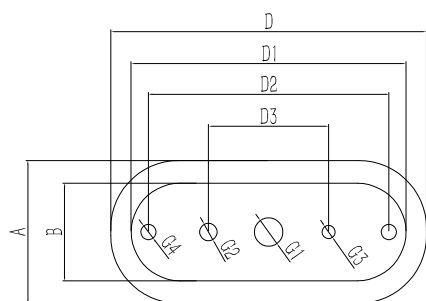

MPES 200 × 150 to 300 × 200

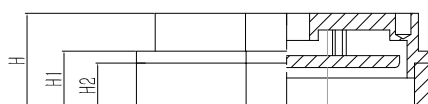
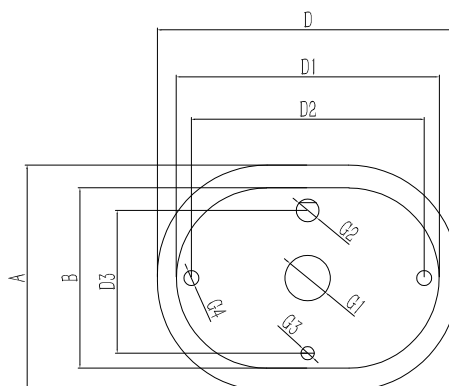

MPES 400 × 300

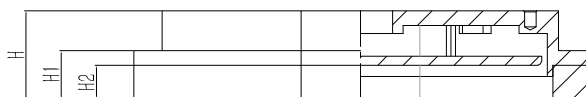
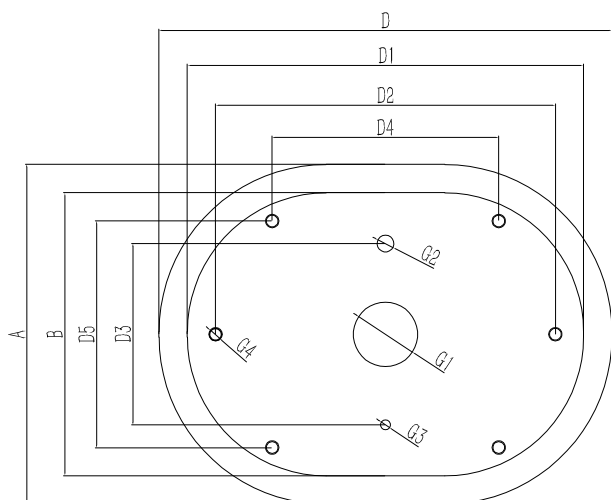

Type	Size [mm]							A	B	H	H1	H2	G1	G2	G3	G4
	D	D1	D2	D3	D4	D5										
MPES 120 × 60 G3/8	120	111	100	-	-	-	60	40	49	20	15	G3/8	-	-	-	M8
MPES 160 × 90 G1/2	160	145	130	80	-	-	90	60	63	38	30	G1/2	G1/4	G1/8	M12	
MPES 210 × 95 G1/2	210	185	160	80	-	-	95	60	63	38	30	G1/2	G1/4	G1/8	M12	
MPES 200 × 150 G1	200	175	160	95	-	-	150	120	63	38	30	G1	G3/8	G1/8	M12	
MPES 300 × 200 G1	300	250	200	115	-	-	200	150	78	38	30	G1	G3/8	G1/8	M12	
MPES 400 × 300 G2	400	350	300	160	200	200	300	250	78	38	30	G2	G3/8	G1/8	M12	